

# FMI125N

Beschikbaar volume

25 l



Product familie

Microgolfoven

Categorie

Inbouw 38 cm

Installatie

Volledig integreerbaar

Voeding

Elektrisch

Bereidingswijze

Microgolf met grill

Bediening

Elektronisch

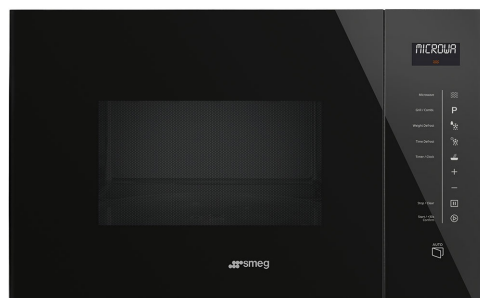

## Programma's / Functies

Aantal functies

6

Grote vlakgrill



Pizza



Ontdooien op tijd



Ontdooien op gewicht



Microgolfoven



Microgolfoven + grill



Automatische programma's

8

## Bediening



Display / Klok

Touch display

Opening

Electrical button

Type

Touch bediening

bedieningsmechanisme

## Opties



Timer

Elektronische timer

Geluidssignaal einde  
kooktijd

Ja

Kinderbeveiliging

Ja

---

Opties  
tijdprogrammering

Eind

---

## Technische specificaties

---

Materiaal ovenruimte	Inox ovenruimte	Opening deur	Side-opening
Aantal lampen	1	Totaal aantal ruiten	1
Type lamp	Gloeilamp	Veiligheidsthermostaat	Ja
Draaiplateau	Ja	Koelsysteem	Mantelkoeling
Afmetingen draaiplateau	31.5 cm	Automatische uitschakeling microgolf bij openen deur	Ja
Automatische inschakeling verlichting bij openen deur	Ja	Afmetingen bruikbare interne ovenruimte (hxbxd)	334x370x221 mm
Type grill	Kwarts	Effectief vermogen microgolf	900 W
Grill - vermogen	1000 W		

---

## Meegeleverde accessoires

---

Ovenrooster	1	Overig	Suction cup
-------------	---	--------	-------------

---

## Elektrische aansluiting

---

Nominale aansluitwaarde	1450 W	Frequentie (Hz)	50 Hz
Stroom	6.3 A	Lengte voedingskabel	130 cm
Spanning (V)	230 V		

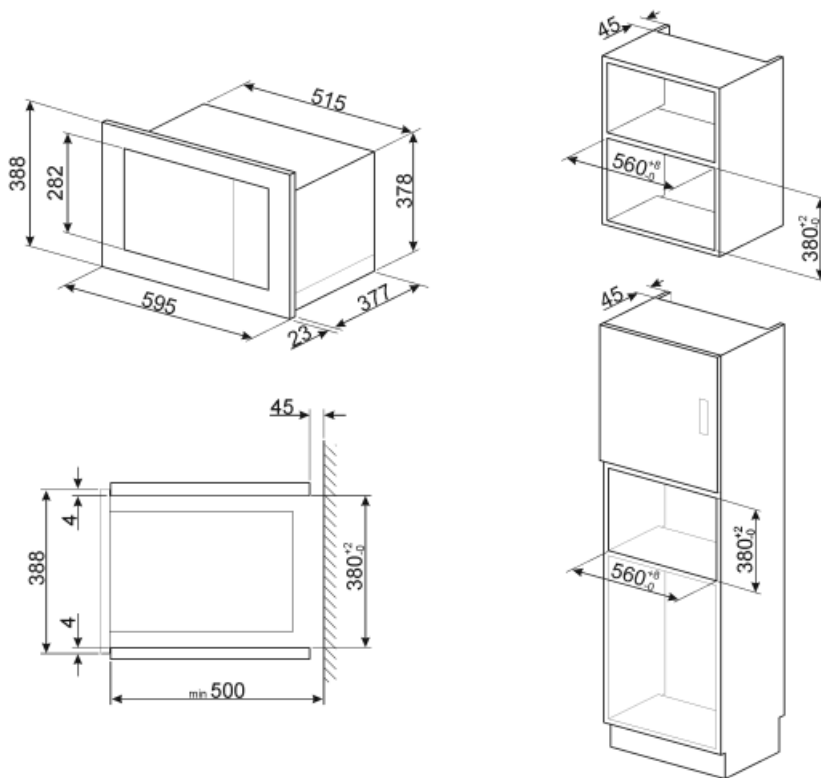

## Not included accessories











---

### KITPLATE



The dish baker is a Teflon-coated aluminum plate with the lower part of ferrous material immersed in a silicone rubber 26,5 cm edges of the flare, 25 cm base

## Symbols glossary (TT)

-  Sommige modellen zijn voorzien van een functie om het programma/de cyclus te blokkeren zodat het niet per ongeluk kan aangepast worden.
-  Defrost by time: Manual defrost function. At the end of the set duration, the function stops.
-  Grill: Very intense heat coming only from above from a double heating element. The fan is not active. Provides excellent grilling and gratinating results. Used at the end of cooking, it gives a uniform browning to dishes.
-  Microwave + grill element: The use of the grill results in a perfect browning of the surface of the food. The action of microwaves allows instead of cooking in a short time the internal part of the food.
-  Bediening met touch knoppen: dankzij de gebruiksvriendelijke aanraakbediening kan het apparaat met één druk op de knop worden geprogrammeerd.
-  Microwave energy shortens cooking times dramatically and produces energy savings.
-  Defrost by weight: Automatic defrost function. You choose the type of food to defrost from the available categories (MEAT - FISH - BREAD - DESSERTS) After entering the weight of the food, the oven automatically defines the time required for proper defrosting.
-  Microwave: Penetrating straight into the food, microwaves cook very quickly and with considerable energy savings. Suitable for cooking without fat, they are also able to thaw and heat food without altering its original appearance and aroma. The microwave function can also be combined with conventional functions with all the resulting advantages. Ideal for all types of food.
-  Pizza microwave: This function cooks pizza quicker thanks to the microwaves. To optimize the final result, use the function combined with the Chef plate
-  The capacity indicates the amount of usable space in the oven cavity in litres.